











36 120 670



- automatische Umstellung
- Abdeckplatte 150 x 90 mm

Passt zu: IMO, MEM, CL.1, CYO

	Chrom	36 120 670-00
	Platin gebürstet	36 120 670-06
	Platin	36 120 670-08
	Dark Chrome	36 120 670-19
	Light Gold gebürstet	36 120 670-27
	Messing gebürstet (23kt Gold)	36 120 670-28
	Schwarz matt	36 120 670-33
	Champagne gebürstet (22kt Gold)	36 120 670-46
	Champagne (22kt Gold)	36 120 670-47
	Chrom gebürstet	36 120 670-93
	Dark Platinum gebürstet	36 120 670-99

Benötigtes Zubehör



UP-Einhandbatterie - 35 020 970 90
 •Max. Einbautiefe 105 mm
 •Min. Einbautiefe 80 mm

Benötigtes Zubehör



UP-Einhandbatterie mit Sicherungseinrichtung - 35 021 970 90
 •Max. Einbautiefe 105 mm
 •Min. Einbautiefe 80 mm

Empfohlenes Zubehör



xGRID Befestigungssatz für die Integration in den Trockenbau - 12 340 970 90

Benötigtes Zubehör



xGRID Montageschiene 555 mm - 12 360 970 90

36 120 670

mm [inches]

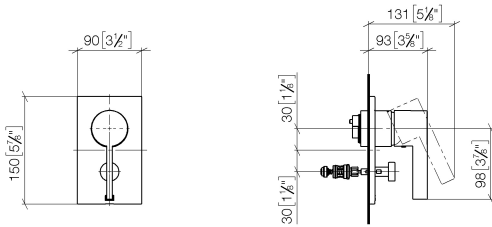

Durchflussdiagramm

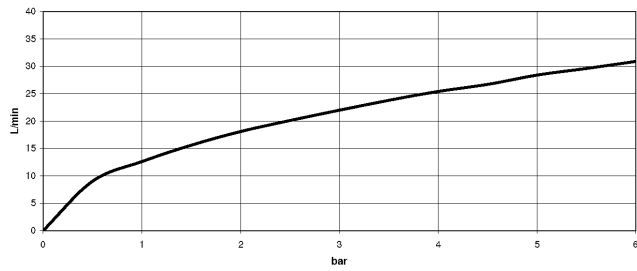

Zertifikate

LGA_19863.

WRAS_2207012.

36 120 670

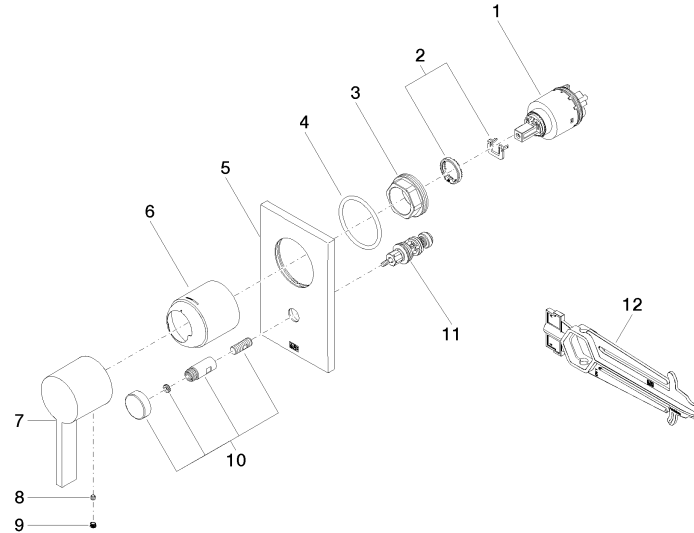

Ersatzteilstückliste

Nr.	Artikelnummer	Benennung	Verbaumenge	Lieferzeit
1	90 15 05 038 00 90	Kartusche	1	60
2	04 28 10 149 00 90	Zubehoer	1	2
3	09 24 04 448 90	Mutter	1	2
4	09 14 10 084 90	Dichtung	1	2
5	09 11 02 258-00	Platte	1	10
6	09 11 02 260-00	Huelse	1	10
7	09 20 67 007-00	Griff	1	10
8	09 31 11 099 90	Stift	1	2
9	90 31 20 109 00 90	Stopfen	1	2
10	90 31 09 139 00-00	Zugstange	1	10
11	90 21 34 081 00 90	Umstellung	1	2
12	90 30 09 064 00 90	Schluessel	1	2